

Paraffin release mechanism

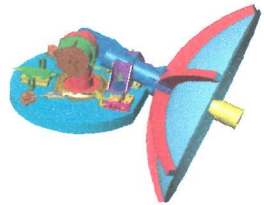

DG Antenna for Chandrayaan

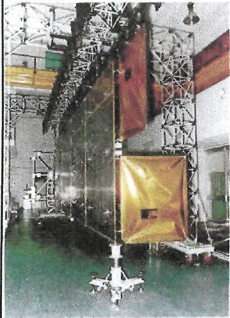

SMA actuated Flap mechanism

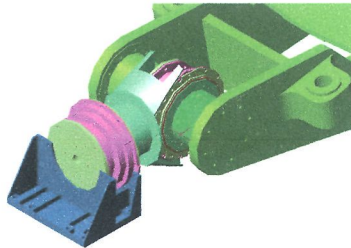

Pointing Mechanism

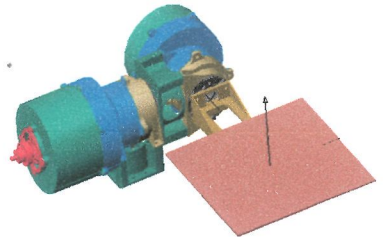

DGA steering

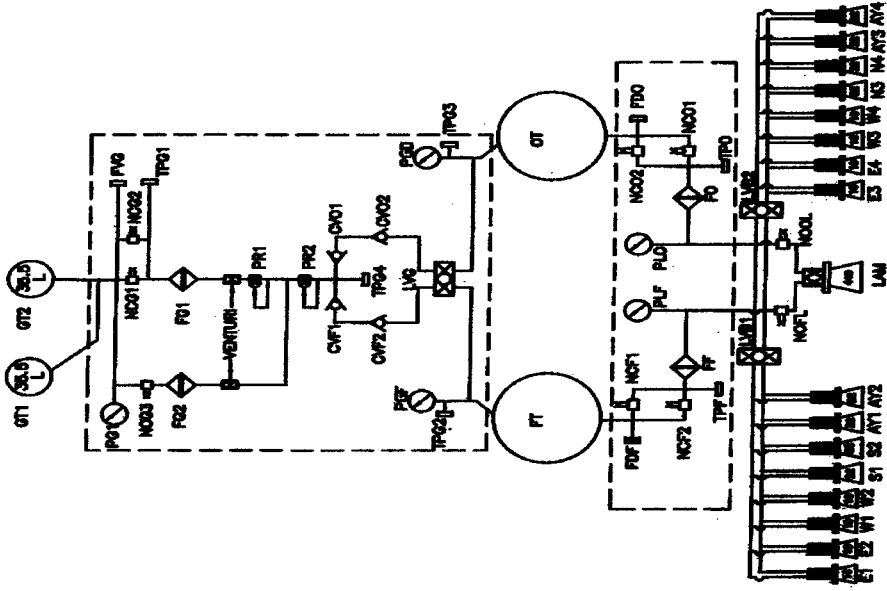

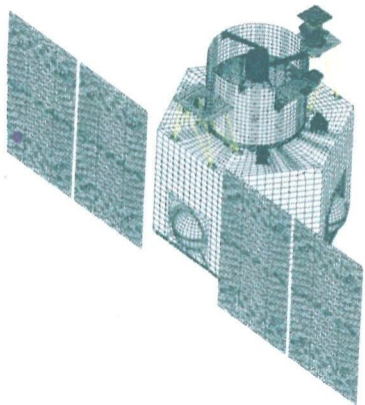
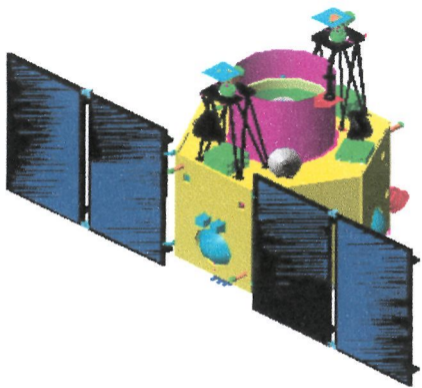

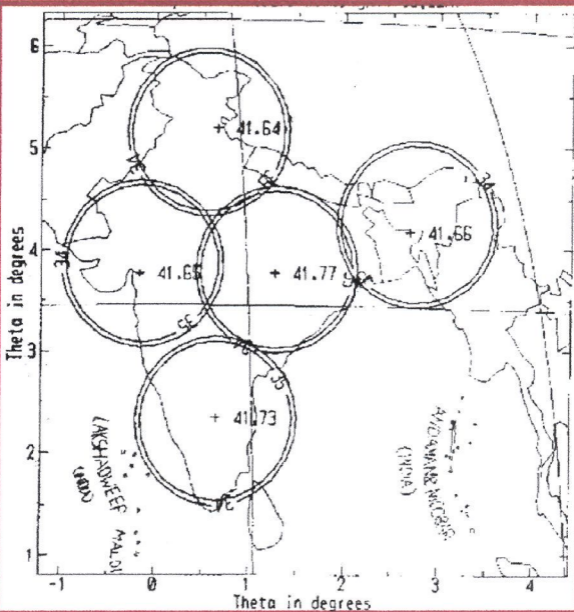





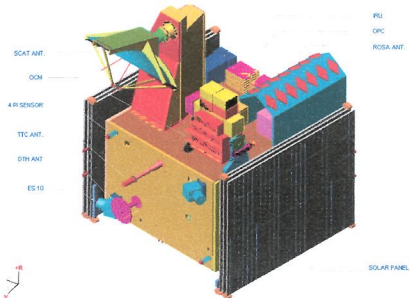

**OCEANSAT-2**

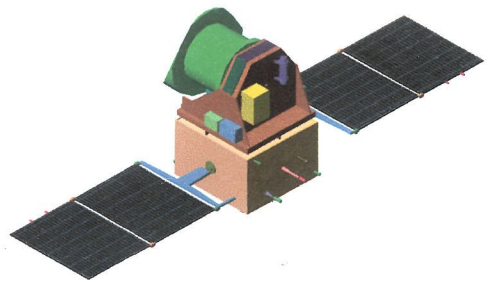

**Meghapropics**

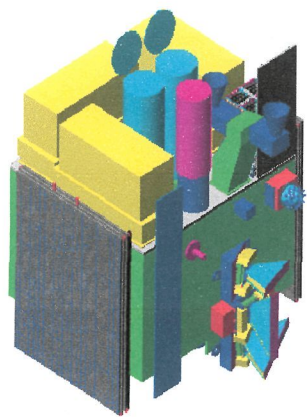

**Astrosat**

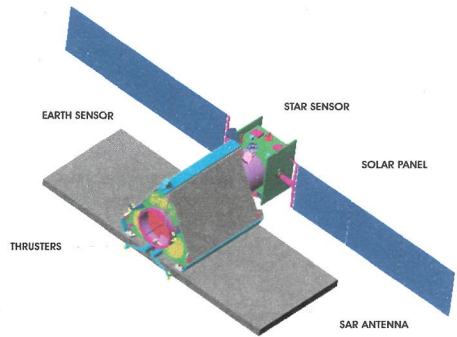

**RISAT**